

A' BRACKET

TT, TN/TNH SWITCH

SN/SNH SWITCH

SS/SSE SWITCH
"U" BODY

ST SWITCH

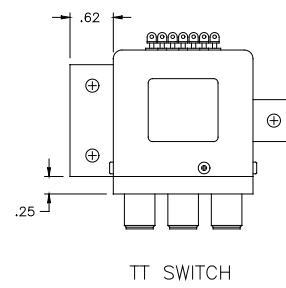
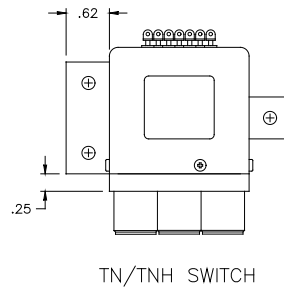
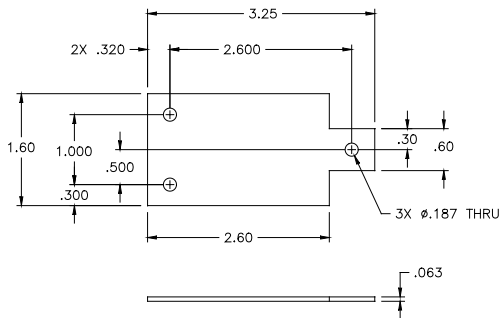

B' BRACKET

TN/TNH SWITCH

TT SWITCH

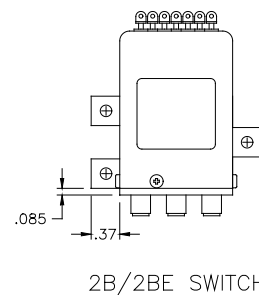
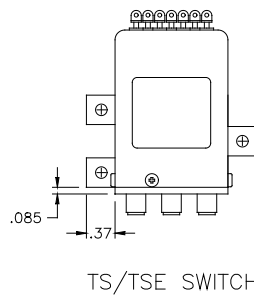
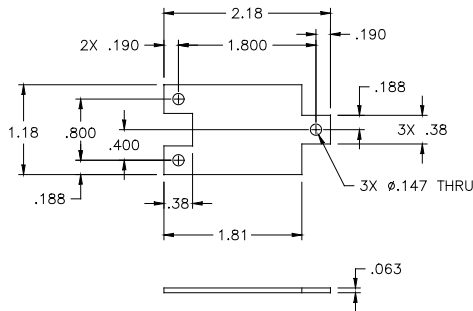

C' BRACKET

TS/TSE SWITCH

2B/2BE SWITCH

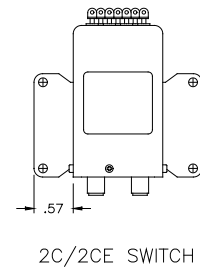
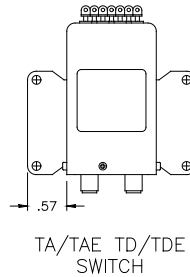
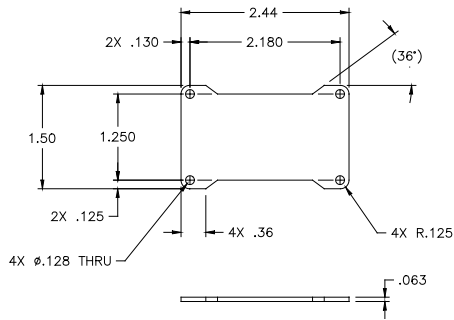

"D" BRACKET

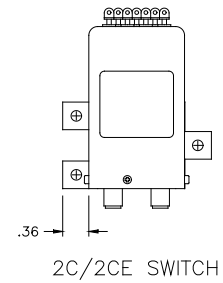
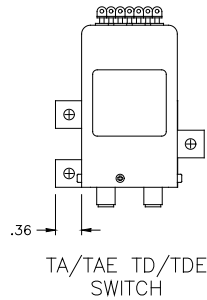
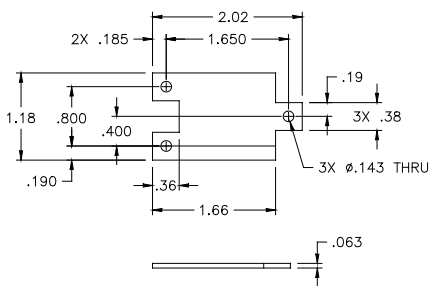

"E" BRACKET

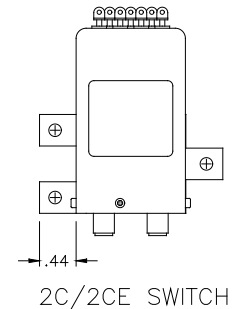
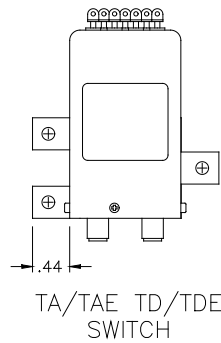
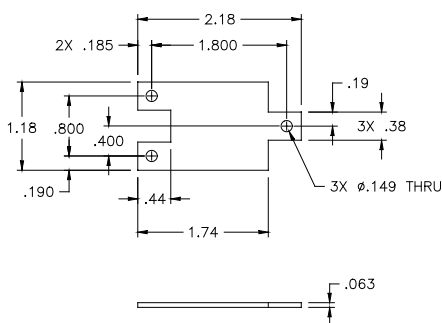

"F" BRACKET

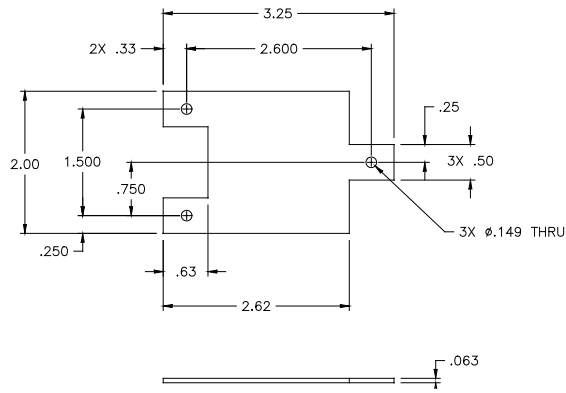

“G” BRACKET

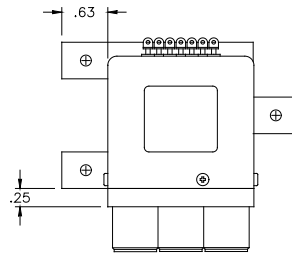

TN/TNH SWITCH

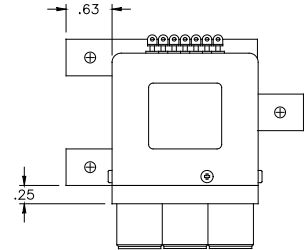

TT SWITCH

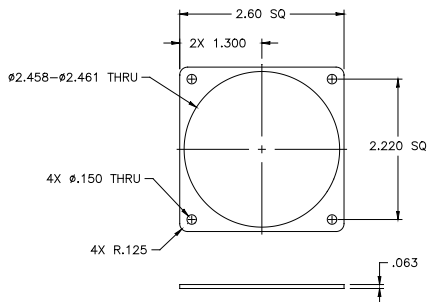

“H” BRACKET

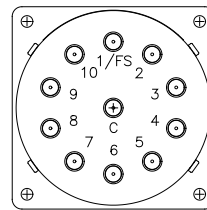

HS SWITCH

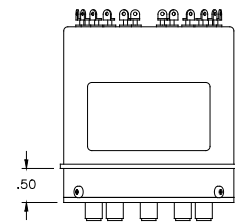

HS SWITCH

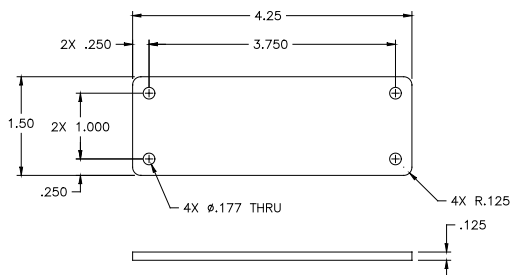

“J” BRACKET

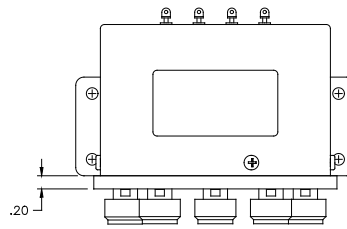

HN SWITCH

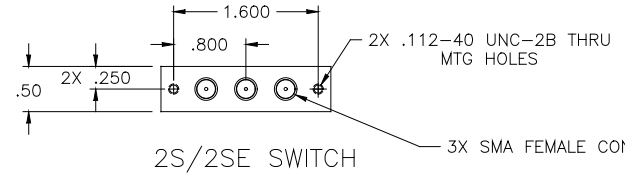
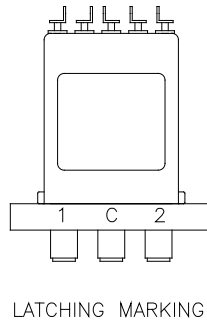
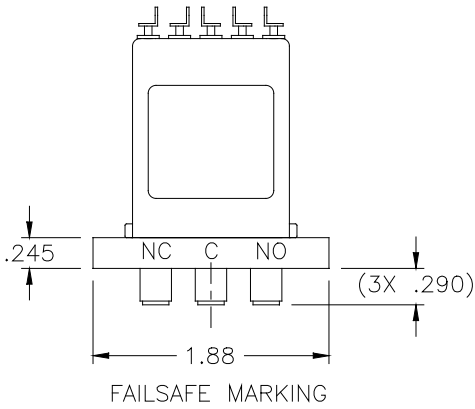

“R” BODY

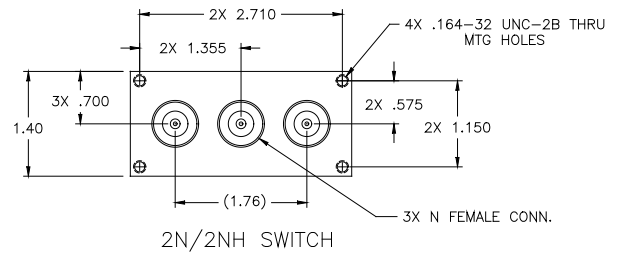
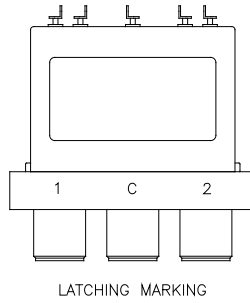
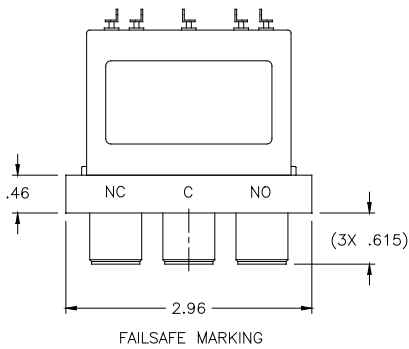

“S” BODY

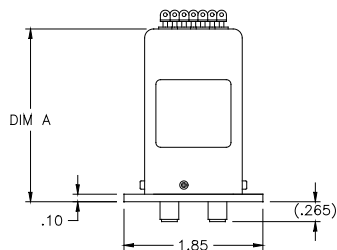

Consult Factory for Dimension “A”

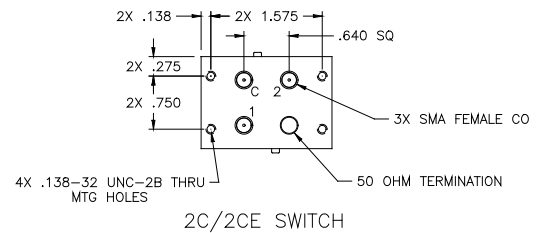
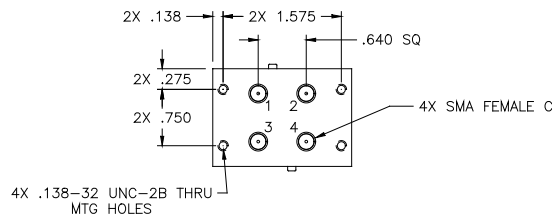

“T” BODY

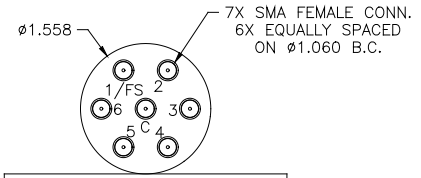
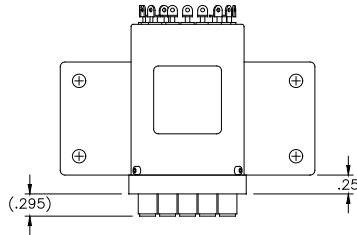

SS/SSE SWITCH
"A" BRACKET

"U" BODY

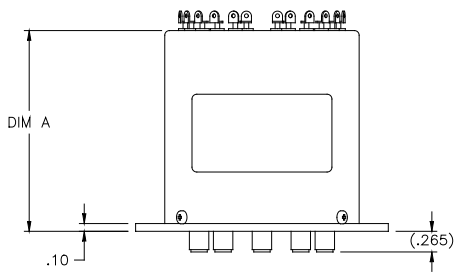

Consult Factory for Dimension "A"

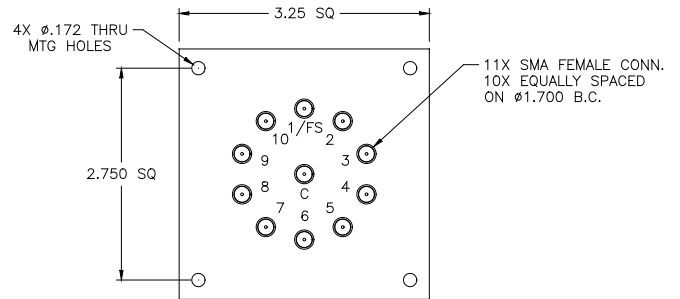

HS SWITCH

"V" BODY